

Spécial indicator lights

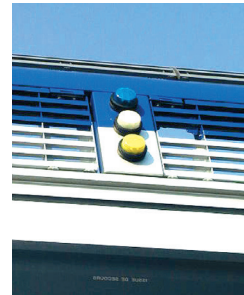

Adaptability
Modularity
Safety
Reliability



Satisfaction guaranteed : custom-build indicator lights.

MAFELEC's indicator lights can be designed to cover all applications :

Stationary or on-board. Railway, industry, lifts, défense ect ..., they comply with the standards in force in each of these fields of activity.







Special indicator lights



LED lights, O.D. 36 mm





















- 7 LEDs, Ø 5 mm - Black plastic body.
- Connection : 6.35 x 0.8 Faston tabs per NFF 00 364 on "O" halogen cable, per NFF 63 808 - Attachment : M 32 x 1.5 threads
- Protective cover withstands detergents - Degree of protection IP65 for front panel (NFC 20010)

Description	Voltage	Colour	Part number	Weight kg
	72V AC/ DC	   	YSP 1138 R2 26 YSP 1138 R3 26 YSP 1138 R5 26 YSP 1138 R6 26	0.023



LED lights, O.D. 40 mm - Cutout Ø: 36 mm

- 18 LEDs, Ø 5 mm . Reverse polarity protection diode.
- Black metal bezel - cannot be removed - Black metal body.
- Connection : Single tab for 6.35 mm clip - Attachment with metal nut and 2 punch screws.
- Degree of protection IP65

Description	Voltage	Colour	Part number	Weight kg
	24V DC	    	P36 LA R5 E 04 F1 5C P36 LA R2 E 04 F1 5C P36 LA R4 E 04 F1 5C P36 LA R3 E 04 F1 5C P36 LA R6 E 04 F1 5C	0.140
	48V DC	    	P36 LA R5 E 05 F1 5C P36 LA R2 E 05 F1 5C P36 LA R4 E 05 F1 5C P36 LA R3 E 05 F1 5C P36 LA R6 E 05 F1 5C	
	72V DC	    	P36 LA R5 E 06 F1 5C P36 LA R2 E 06 F1 5C P36 LA R4 E 06 F1 5C P36 LA R3 E 06 F1 5C P36 LA R6 E 06 F1 5C	
	110V DC	    	P36 LA R5 E 07 F1 5C P36 LA R2 E 07 F1 5C P36 LA R4 E 07 F1 5C P36 LA R3 E 07 F1 5C P36 LA R6 E 07 F1 5C	



Connection via screws/clamp plate IP2X or long version for front panel from 1 to 37 mm in depth: Contact us.

Dimensions

Cutouts

YSP 1138.

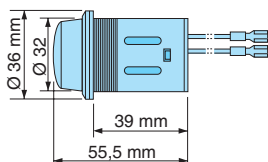

P36 LA.

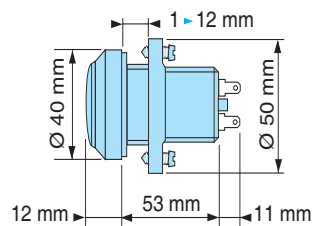

Panel cutouts
(from 1 to 12 mm in depth)

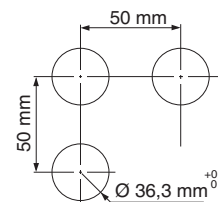

Special indicator lights



LED lights, O.D. 45 mm - Cutout Ø: 39 mm

- 2 x 6 LEDs - Reverse polarity protection diode - Current consumption 40 mA max.
- Body and bezel in bright anodised aluminium - Attachment by metal nut and 2 punch screws.
- Connection : AMP connector on teflon cable.
- Degree of protection IP65 for the front panel

Description	Voltage	Colour	Part number	Weight kg
	37.5V DC (24 to 44V)	Amber (standard)	YSP 1154	0.120

Other possible colours - White, Blue, Green, Red
Contact us.



LED lights, O.D. 57 mm - Cutout Ø: 50 mm

- 2 x 6 LEDs - Reverse polarity protection diode - Current consumption 40 mA max.
- Body and bezel in bright anodised aluminium - Attachment by metal nut and 2 punch screws.
- Connection : AMP connector on teflon cable.
- Degree of protection IP65 for the front panel

Description	Voltage	Colour	Part number	Weight kg
	37.5V DC (24 to 44V)	Amber (standard)	YSP 1080	0.195

Other possible colours - White, Blue, Green, Red
Contact us.



Dimensions

Cutouts

YSP 1154

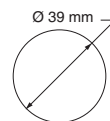
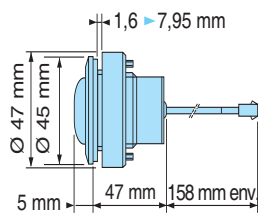

YSP 1080

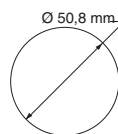
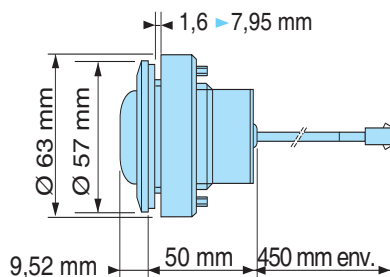

Special indicator lights



LED lights, O.D. 82 mm - Cutout Ø : 56 mm

- Amber : 3 x 10 LEDs, Ø 5 mm - White : 6 x 5 LEDs, Ø 3 mm.
- Brightness control system - Power consumption : 100mA max. - Connection : Screw terminal block.
- Smooth or lens-type protective cover - Degree of protection : IP 66 for the front panel.
- Metal body - Metal tightening ring and punch screws.

Description	Voltage	Colour	Part number	Weight kg
Round LED light. Large size. Brightness control.	24V AC	● ○	YSP 1171 YSP 1173	0.20

Other colours or operating voltages:
Contact us



- 2 x 12 LEDs, Ø 5 mm
- Power consumption: 30mA nominal - Connection : Double 6.35 x 0.8 mm Faston tabs.
- Smooth or lens-type protective cover - Degree of protection : IP 66 for the front panel.
- Metal body - Metal tightening ring and punch screws.

Description	Voltage	Colour	Part number	Weight kg
Round LED light. Large size.	72V DC	●	YSP 1128	0.20

Other colours or voltages:
Contact us



- Amber : 2 x 15 LEDs, Ø 3 mm.
- Brightness control system - Power consumption : 100mA max. - Connection : Screw terminal block.
- Smooth or lens-type protective cover - Degree of protection : IP 66 for the front panel.
- Metal body - Metal tightening ring and punch screws.

Description	Voltage	Colour	Part number	Weight kg
Round LED light. Large size. Side lighting.	24V AC	●	YSP 1172	0.20

Other colours or operating voltages:
Contact us



Dimensions

Cutouts

YSP 1171 / 72 / 73

YSP 1128

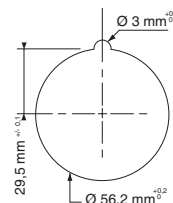
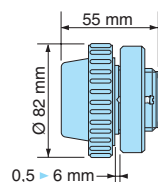
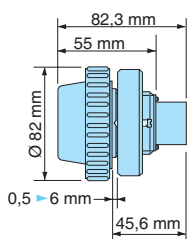

Special indicator lights



Lamp indicator lights, O.D. 82 mm - Cutout Ø: 40 mm max.

- 2 festoon lamps provided - Railway approvals (vibration resistance) - Mounted on PCB complying with EZ 5004.
- Interchangeability : From the front without removing the light.
- Protective cover fastening : By chrome-plate metal nut.
- Visible from de side and front.
- Connection : By tab for 6.35 clip.
- Degree of protection : IP66

Description	Voltage	Colour	Part number	Weight kg	
Round light with festoon lamps.	12V DC	●	YSP 1083 R5 03	F1 1	0.130
		●	YSP 1083 R2 03	F1 1	
		●	YSP 1083 R4 03	F1 1	
		●	YSP 1083 R3 03	F1 1	
		●	YSP 1083 R6 03	F1 1	
		⊗	YSP 1083 R8 03	F1 1	
		○	YSP 1083 R9 03	F1 1	
	24V DC	●	YSP 1083 R5 04	F1 1	
		●	YSP 1083 R2 04	F1 1	
		●	YSP 1083 R4 04	F1 1	
		●	YSP 1083 R3 04	F1 1	
		●	YSP 1083 R6 04	F1 1	
		⊗	YSP 1083 R8 04	F1 1	
		○	YSP 1083 R9 04	F1 1	
	48V DC	●	YSP 1083 R5 05	F1 1	
		●	YSP 1083 R2 05	F1 1	
		●	YSP 1083 R4 05	F1 1	
		●	YSP 1083 R3 05	F1 1	
		●	YSP 1083 R6 05	F1 1	
		⊗	YSP 1083 R8 05	F1 1	
		○	YSP 1083 R9 05	F1 1	
72V DC	●	YSP 1083 R5 06	F1 1		
	●	YSP 1083 R2 06	F1 1		
	●	YSP 1083 R4 06	F1 1		
	●	YSP 1083 R3 06	F1 1		
	●	YSP 1083 R6 06	F1 1		
	⊗	YSP 1083 R8 06	F1 1		
	○	YSP 1083 R9 06	F1 1		



Other connection :

D1 = Double tab for 5 mm clip

Example : YSP 1083 R9 06 **D1** 1

Other attachment :

3 = Black plastic nut

Example : YSP 1083 R9 06 **F1** **3**

WARNING! Some Part Numbers are not held in regular stock (contact us)

Dimensions

Cutouts

YSP 1083

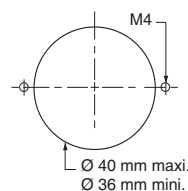
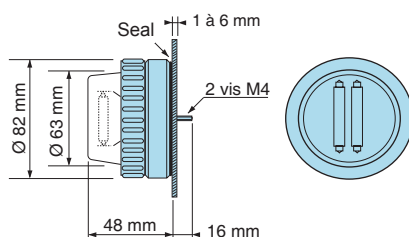

Special indicator lights



External signalling units

- Compliance with standards : NFF 62000 - NFA 91102 - NFE 25100 - NFE 25032
- Specially designed for maintainability.
- Assembly comprising :
 - 1 support frame : Cast aluminium, grey epoxy metallic paint 862 (French railway P/N) withstands detergents.
 - Sealing IP66 - NFC 20010 (with drainage for condensation).
 - 2 or 3 lights, Ø 80 fitted with two 45V - 8W festoon lamps Railway approvals (vibration resistance), mounted on a PBC complying with EZ 5004.
- Connection : connector for 6.35 clips.
- Interchangeability : From the front without removing the unit.
- Illumination visible from the front and sides.
- Colours : Blue, White, Yellow
- Supply voltage : 83V nominal (variation from 50 to 90V).
- Wiring : 0.93 mm² wires, "O" halogen NFF 63808.
- Attachment : 4 captive CHC M5 x 30 screws.

Description	Voltage	Colour	Part number	Weight kg
2-light signalling unit, round version.	50V to 90V DC	1 st light: Crystal 2 nd light: Yellow	YSP 1072	0.670
3-light signalling unit, round version.	50V to 90V DC	1 st light: Blue 2 nd light: Crystal 3 rd light: Yellow	YSP 1071	0.725

Other voltages, light colours or supports:
Contact us.



Dimensions

YSP 1071

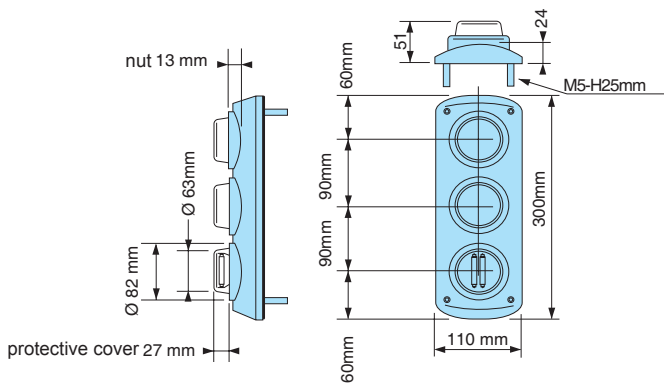

YSP 1072

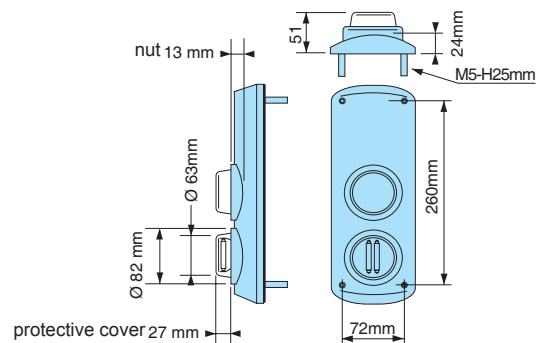

Special indicator lights



Flat LED lights

- 18 LEDs, Ø 5 mm - 2 circuits, each with 9 LEDs
- Protective cover (Ø 40 mm) cannot be disassembled (vandal-proof), mounted in a grey plastic casing.
- Reverse polarity protection diode.
- Connection : **+ terminal** : 1 single 5 x 0.8 tab. **- terminal** : 1 single 6.35 x 0.8 tab.
- Degree of protection : IP 65
- Attachment : By 2 M4 screws for oblong holes, 15 x 5 mm, on sheet metal.

Description	Voltage	Colour	Part number	Weight kg
Flat light	24V DC	●	YSP 1082 R5 04	0.145
		●	YSP 1082 R2 04	
		●	YSP 1082 R4 04	
	48V DC	●	YSP 1082 R5 05	
		●	YSP 1082 R2 05	
		●	YSP 1082 R4 05	
	72V DC	●	YSP 1082 R5 06	
		●	YSP 1082 R2 06	
		●	YSP 1082 R4 06	



Other version :
Light with flush protective cover, P/N: YSP 1093 . . .

- 19 LEDs, Ø 5 mm
- One-piece protective cover and housing (protective cover Ø 40 mm)
- Reverse polarity protection diode
- Connection : Deutsch Connector : DT04-2P
- Degree of protection : IP 65 (flat gasket)

Description	Voltage	Colour	Part number	Weight kg
Flat one-piece light	72V DC	●	YSP 1178 R5 06	0.05
		●	YSP 1178 R2 06	
		●	YSP 1178 R4 06	
	110V DC	●	YSP 1178 R5 07	
		●	YSP 1178 R2 07	
		●	YSP 1178 R4 07	



- 19 LEDs, Ø 5 mm
- One-piece protective cover and housing (Ø 40 mm protective cover)
- Reverse polarity protection diode
- Connection : Deutsch Connector : DT04-2P
- Degree of protection : IP 65 (flat gasket)

Description	Voltage	Colour	Part number	Weight kg
Flat one-piece light, flashing (3 Hz)	72V DC	●	YSP 1178 R5 06	0.05
		●	YSP 1178 R2 06	



Dimensions

YSP 1082
YSP 1093 (flush protective cover)

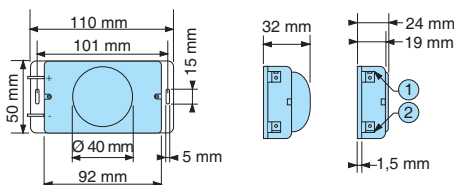

YSP 1178

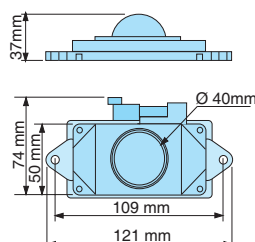

Special indicator lights



Beacon-style LED lights (3-way visibility)

- 31 LEDs, Ø 5 mm - 2 side circuits, each with 8 LEDs - 1 front circuit with 15 LEDs
- Protective cover with Fresnel lens on the front, smooth at the sides
- Reverse polarity protection diode
- Connection : Double 5 or 6.35 mm tabs.
- Degree of protection : IP 65 for the front panel.
- Attachment : Sliding attachment clamp. Fastening by 3 M3 screws.

Description	Voltage	Colour	Part number	Weight kg
LED light. Large size. 3-way visibility	24V DC	●	YSP 1264A . 24	0.10
		●	YSP 1264A . 26	
		●	YSP 1264A . 23	
		○	YSP 1264A . 29	
	72V DC	●	YSP 1264A . 44	
		●	YSP 1264A . 46	
		○	YSP 1264A . 49	
	110V DC	●	YSP 1264A . 64	
		●	YSP 1264A . 66	
		○	YSP 1264A . 69	

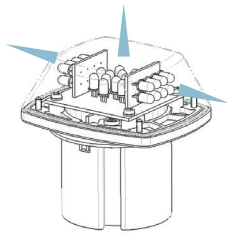

1 = Fastons 5
2 = Fastons 6,35

LED Tail light

- 30 LEDs, Ø 5 mm - 2 circuits, each with 15 LEDs
- Protective cover with Fresnel lens on the front, smooth at the sides
- Reverse polarity protection diode
- Connection : Double 6.35 mm tabs.
- Degree of protection : IP 65 for the front panel.
- Attachment : Sliding attachment clamp. Fastening by 3 M3 screws.

Description	Voltage	Colour	Part number	Weight kg
Tail light	48V AC	●	YSP 1198AI15R4F2	0.10
		●	YSP 1198AI15R5F2	
	110V DC	●	YSP 1198AF07R2F2	



Dimensions

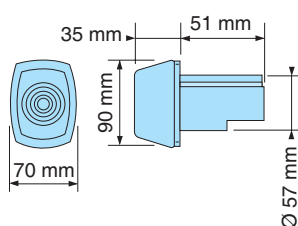

Cutouts

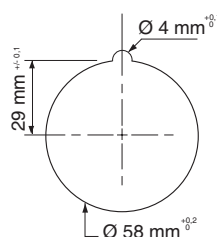

Consult our other catalogues

Catalogue **A6-1**

Control components



Catalogue **B2-1**

Standard 16 A switches and Low level switches with self-cleaning contact



Catalogue **B3-2**

16A to 400A AC/DC Snap action switches



Catalogue **E1-4**

Standard and special Indicator lights



Catalogue **E7**

LED Marker / Tail lights



Catalogue **E8**

Display & Signalling

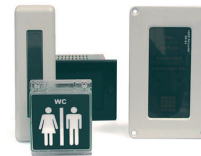

Catalogue **G1-2**

Low and medium voltage Insulators and Partitions bushings



Catalogue **F4-1**

Contact us

BR500 junction terminals

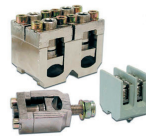

Catalogue **F2-2**

Stud junction terminals

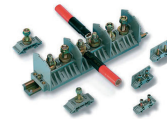

Catalogue **L1**

Watertight control boxes



Catalogue **D2-2**

Pendant control boxes



Catalogue **L2**

Contact us

ORCA Range

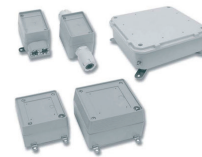

471 Route de la Cuisinière
38 490 CHIMILIN-FRANCE
Ph. : +33 (0) 4 76 32 07 33
Fax. : +33 (0) 4 76 32 54 11
Mail: contact@mafelec.fr
www.mafelec.com