

Company* :

Select your activity* :

Project :

N° plan :

* Mandatory fields

1 - Mounting

Front mounting
with bezel

Rear mounting
without bezel

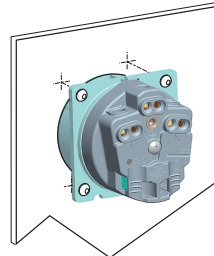
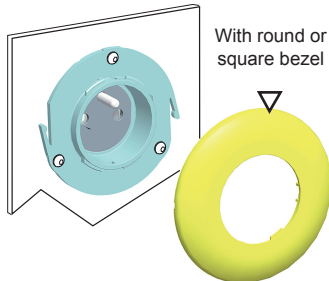

[View example](#)

2 - Type of product

(presented examples :
front mounting)

Outlet NCF61314

Outlet NCF61314
protected electrical
network

Outlet DIN49440

Outlet DIN49440
protected electrical
network

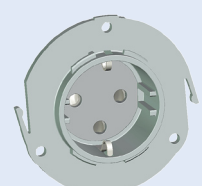
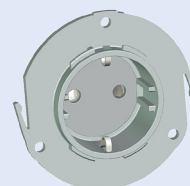
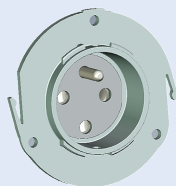
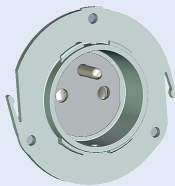

Non illuminated

Illuminated

3 - Electrical characteristics for illuminated socket

Operating voltage : 24 V

130 V

230 V

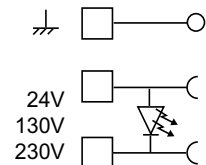

4 - Color of LED

White

Green

Red

Blue

Amber

Other

5 - Bezel for front mounting

Shape : Round plastic

Round metal

Front Label, for rear mounting
(contact us)

Square metal

Round metal
(with 2 areas of marking)

Color : Green

Red

Dark blue

Light blue

Yellow

Light grey

Dark grey

Orange

Decorative chrome
(for metal version only)

[View example](#)

6 - Back of the outlet

Color : Light grey (standard)

Other (contact us)

Red (protected electrical network)

[View example](#)

7 - Sealing

Plug for front side - IP66
(NCF61314 version only)

[View example](#)

8 - Accessory and tool (options)

Safety mis-connection device for
protected electrical network
to assemble on male plug

Dismounting tool for bezel
(front mounting)

[View example](#)

Dimensions (mm)

[Return](#)

Front mounting :

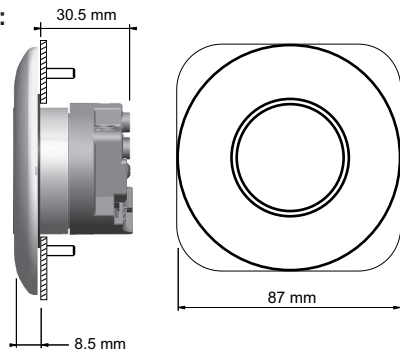

Rear mounting :

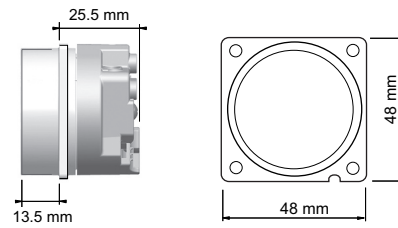

Bezel - Plate

[Return](#)

Round shape, metal or plastic with areas of marking (text or Braille)



Square shape, metal



Label or plate for rear mounting (contact us)



Colors of bezels

[Return](#)

Colors are given as a rough guide and can vary according to the material (metal or plastic)



Back colors of the customized socket

[Return](#)

ex: outlet with protected electrical network

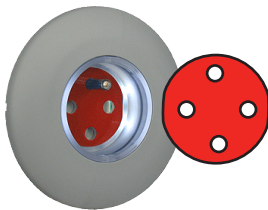

ex : other color and marking

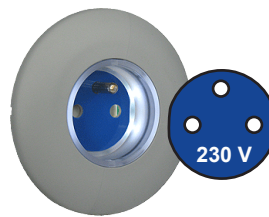

Accessories and tool

[Return](#)

Safety mis-connection device for protected electrical network to assemble on male plug

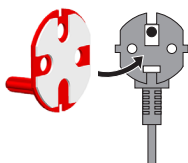

Plug for front - IP66 (NFC61314 version only)



Dismounting tool for bezel (front mounting)



Other versions of socket on request